



TECNOFORM®

Pik-0 Cabinetry Kit

for Mercedes Sprinter

Technical data & features

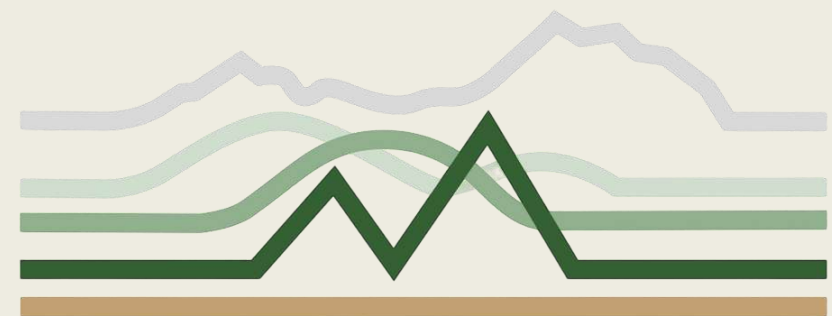

making your journey easier

Structure & Materials

The cabinetry kit for Mercedes Sprinter 2LH2 is designed and manufactured within an **industrial process at Tecnoform Spa, Italy.**

The body components are in solid **poplar plywood laminated with HPL, thickness 17 mm.**

Strong points:

- High quality, professional look
- Sleek Italian design, robust appeal
- Durable and stable components
- Easy to clean and practical for everyday use

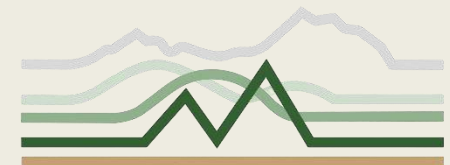

Structure and Materials

High quality hardware pack included:

- Concealed handles
- Push-locks
- Hinges
- Drawers slides

Cabinets, upper lockers and wardrobe space are equipped for secure storage on the move.

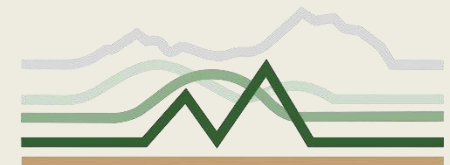

Technical Highlights

Body Kit ready for flexible assembling

The Installer will adapt the edges of the furniture according to the inner insulation skin selected.

Edges to frame highlighted in **GREEN**

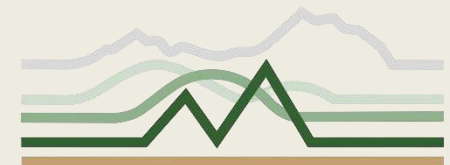
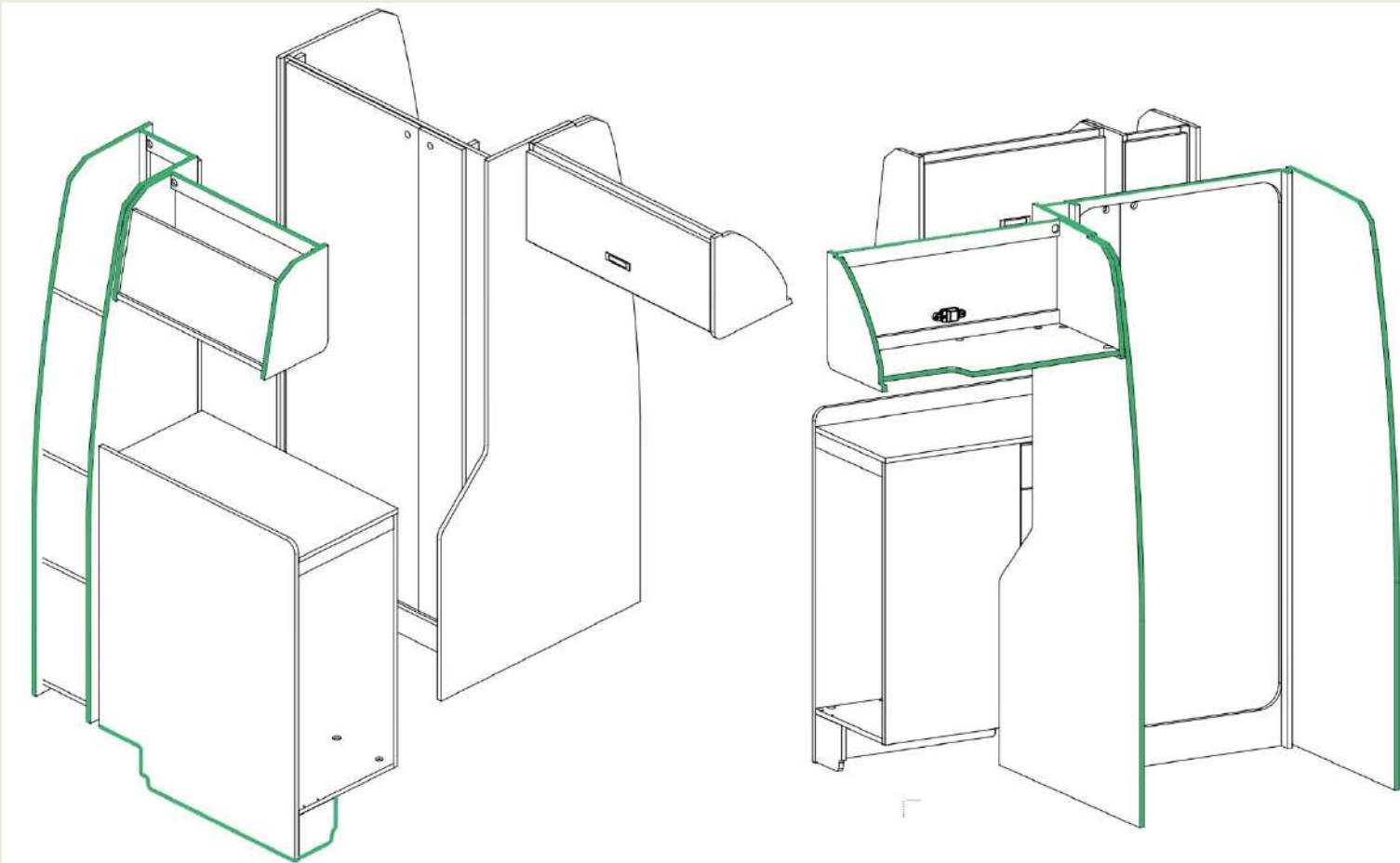

Extra Materials

Add-on building materials available:

- Laminated panels thickness 17 mm
- Edgebanding

This will guarantee:

- Spare parts availability
- Build customized tables, shelves, and other specific components requested by the End User.

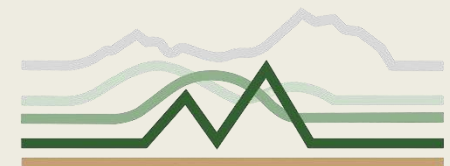

Colours and packaging

Flat Pack delivery mode

- Kits can be stacked by quantity 5 on a standard Pallet

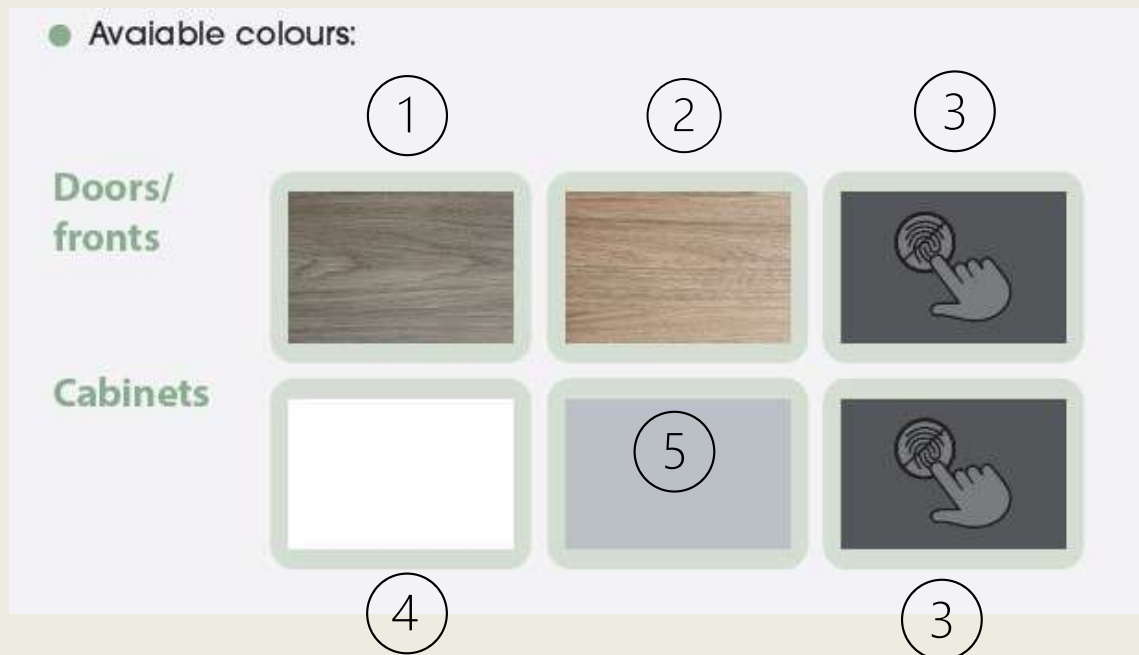

1. Weathered teak
2. Tiberino wood
3. Premium black
4. Optical white
5. Velvet Grey

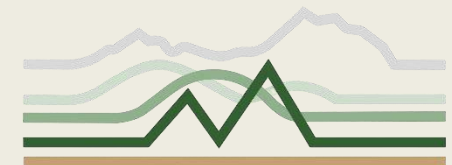

Additional Features

Cooking, Washing, Lighting

Pik-0 is compatible with:

- Dimatec Lighting systems
- IndelB Fridge CR86 - 85L, 50 Watt

The Installer will select and fit:

- Burner Hob
- Sink
- Tap
- Toilet thermoformed parts and accessories

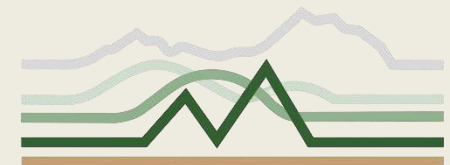

Flyer in summary

Pik-0

Furniture kit for 2LH2 Mercedes Sprinter



Kit structure

- Kitchen
- Wardrobe
- Two OVH cabinets
- Bathroom set
- Extra DIY panels

Benefits

- Easy to assemble with hidden fixing
- High-quality RV specific materials
- Flexible layout (customizable panels)
- Materials by FSC and PEFC certified suppliers

Note for installer

- The kitchen block is ready for IndelB CR86 fridge
- Cooker, sink and tap freely selectable
- Customizable bathroom
- Flat pack packaging

Choice

- Available colours:

Doors/
fronts



Cabinets



Produced by **TECNOFORM®**
The RV Furniture Brand

Tecnoform.com
Tecnoform_official



 making your journey easier

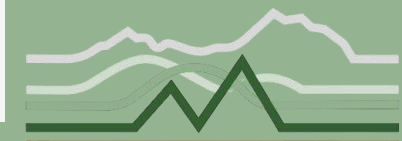



TECNOFORM[®]

2024

**Caravan Salon
Düsseldorf**

Thanks
for the
attention

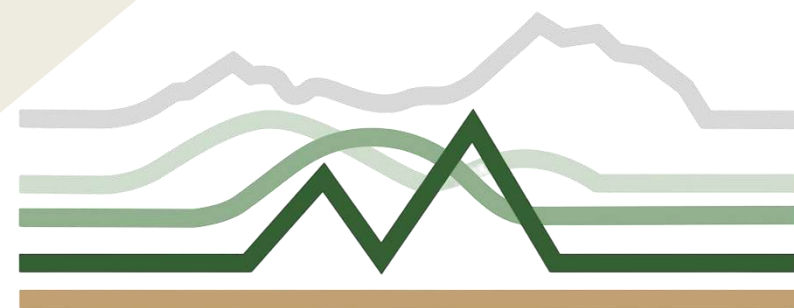

making your journey easier